

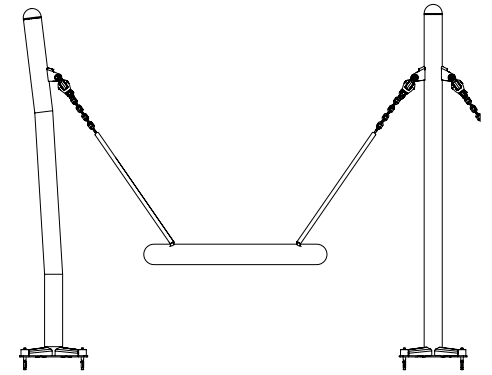









**OM**



1	43-04818		4 x CAP 10, Ø17x14,5 mm	0.01 kg
2	43-04820		4 x Cover 10, Ø25x12mm	0.00 kg
3	8019914		4 x Expansion anchor M12x106 HDG	0.08 kg
4	8008796		2 x Nut, Fujilok-M10-8-RingA2	0.011 kg
5	SW65420		1 x	23.36 kg
6	SW75576		1 x	24.08 kg
7	SW84435		2 x	0.93 kg
8	8008383		2 x Screw, ISO4014-M10x60-8.8	0.0479 kg
9	8071044		4 x Washer ISO7092-10.5x18.1.6	0.002 kg
10	43-04821		2 x Ø10,5x34x4 mm	0.00 kg

